



**1502SD01806/
1502SD01807
RECLINER
1 seater/
3 seater**

Smarter
Comfortable
Smoother

CUSTOMER PROFILE

Market Segment : Indian middle and higher middle class - Prioritizer

User Profile :

- High disposable income
- Well educated
- Hygiene conscious
- Brand , aesthetic, design and trend aware
- Willing to experiment with shades
- Frequent traveler

Buying Considerations

- Contemporary design
- Top of the line aesthetics
- Excellent fit and finish
- Price of the product



TARGET FUNCTIONALITIES

Comfort : The soft foam provides sinking feeling along with floating effect while seating and reclining.

Ease of operation : Smooth and noiseless mechanism which is easy to operate and can be inclined at any angle as per requirement.

Storage/Display Surface : Magazine pocket at each recliner adds to the functionality. Also, the embedded coffee table in three seater recliner gives a HOME THEATRE experience

Craftsmanship : Stitching lines are crafted with precision and exact symmetry at every geometrical lines on seat and back.

Maintenance : Easy to clean and wipe the upholstery



1502SD01806
1 seater

Shade :
Brown

1502SD01807
3 seater



Shade :
Brown

1502SD01807

3 seater



Shade : Caramel
brown

SPECIFICATIONS :



Upholstery

- Material : Synthetic Leather (PVC) , Fabric
- Color : Brown , caramel brown
- Thickness : 1 mm

Frame :

- Material : Combination of plywood and pine Wood
- Plywood thickness : 12 mm (moisture resistance and termite free)
- Pinewood cross section (without knots) Moisture content : 10 -12 %

Foam

Seat :

- Material : Slab stock foam
- Density : Base 28 kg/m³ and super soft 32 kg/m³ at top Pocket spring of diameter 2 mm is embedded in seat

Back :

- Material : Slab stock foam of density 28 kg/cubic m is pasted on back.
- The front of the backrest is made of loose conjugated polyester fibre which is weighed & filled in the upholstery to make the required cushion

Armrest :

- Soft conjugated polyester fiber is filled in upholstery cushions

Webbing

- S spring of wire diameter of 3.8 mm

Mechanism

- LP mechanism. It is made up of mild steel linkages which are riveted together. The reclining mechanism is tested for 158 kg load.

Legs : PVC bushes fitted at the bottom surface of reclining mechanism

Top of coffee table in 3 seater : Membrane pressed on MDF

DIMENSION

S :

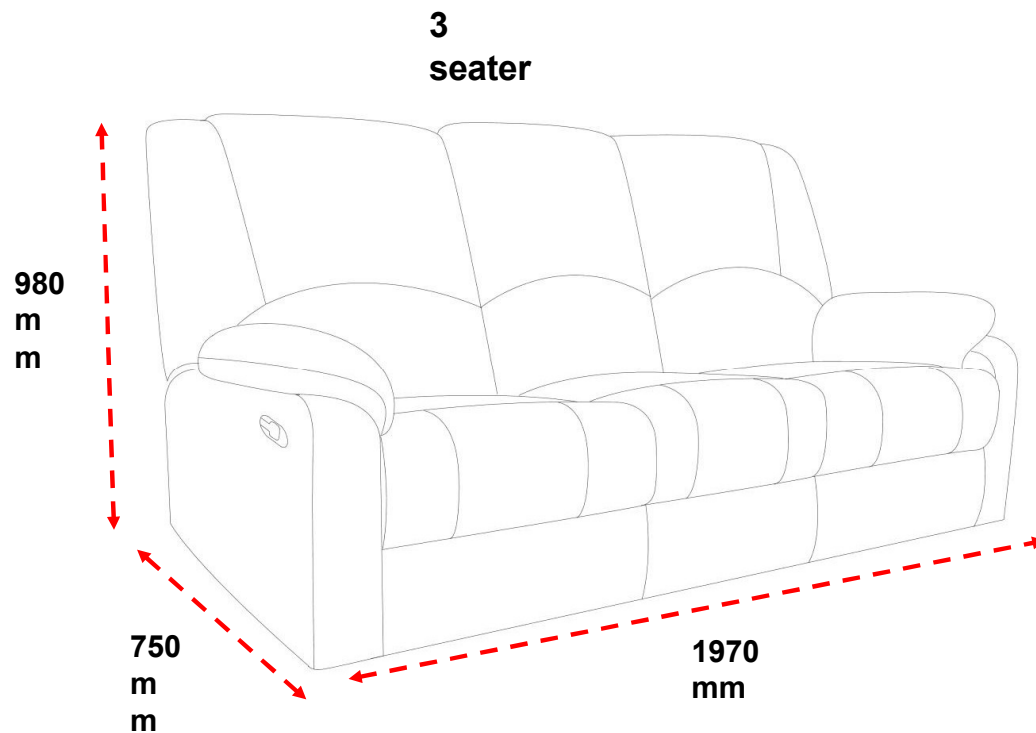
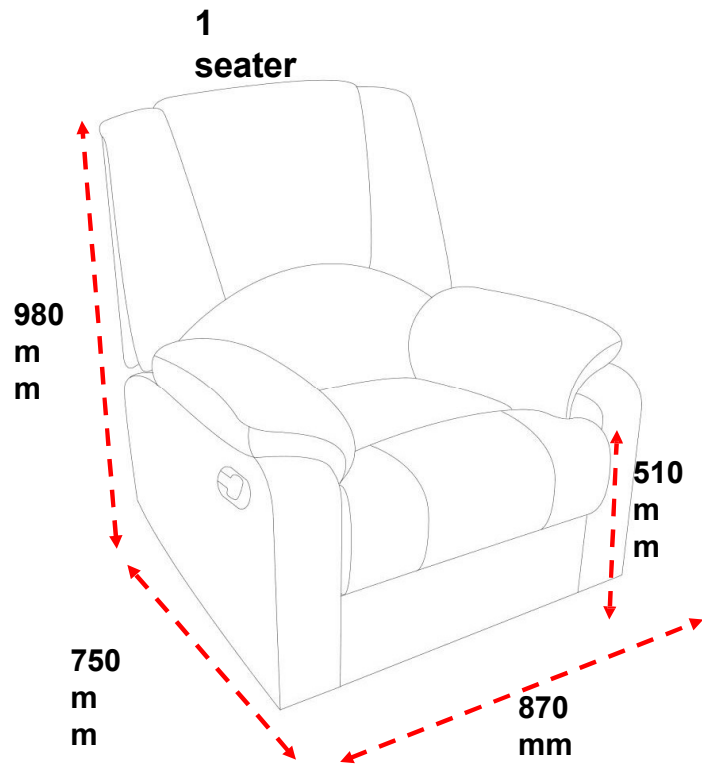

Features of Rhine V3 that supersedes existing Rhine

Smooth transition throughout reclining range allowing user to select any position instead of 3 set positions in the earlier model

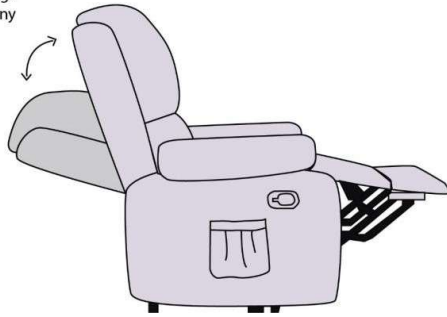

"Wall hugger mechanism" allowing sofa to be placed within 6 inches from the wall

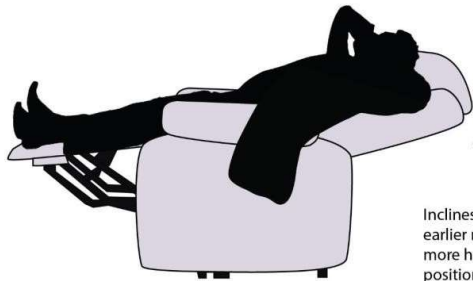
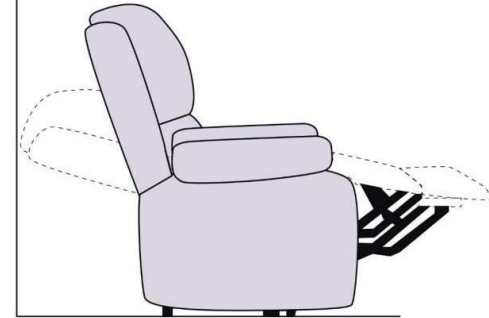

Inclines 4 degree more than earlier mechanism, allowing more horizontal reclining position for a quick nap



Enhanced lumbar support making hours of binge - watching comfortable

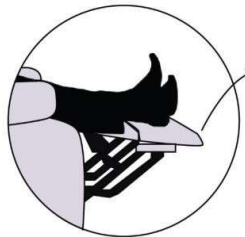

Stronger footrest to hold reclining position for heavier loads.

USPs

:

- Syn Lth upholstery which is much superior than EPU which has high resistance to peeling, scratches and abrasion
- Leggett and Platte mechanism which is smooth, noiseless and effortless which reclining. The mechanism can be inclined at any angle as per the requirement of the user unlike the existing mechanism which can be reclined at there levels only. Also the mechanism inclines 4 degree more than the existing mechanism
- Soft foam with embedded pocket spring for comfort with floating feeling at seat
- Soft conjugated polyester fiber filler at armrest and backrest for cushioning effect.
- Enhanced lumbar support which offers exceptional comfort
- High backrest with head support for comfort and relaxation
- Magazine pocket for storage which adds to the functionality
- Embedded coffee table at 3 seater Rhine provides a HOME THREATRE EXPERIENCE
- Three years warranty offered against manufacturing defect like structural deformation of frame and malfunction of reclining mechanism

TALKING POINTS :

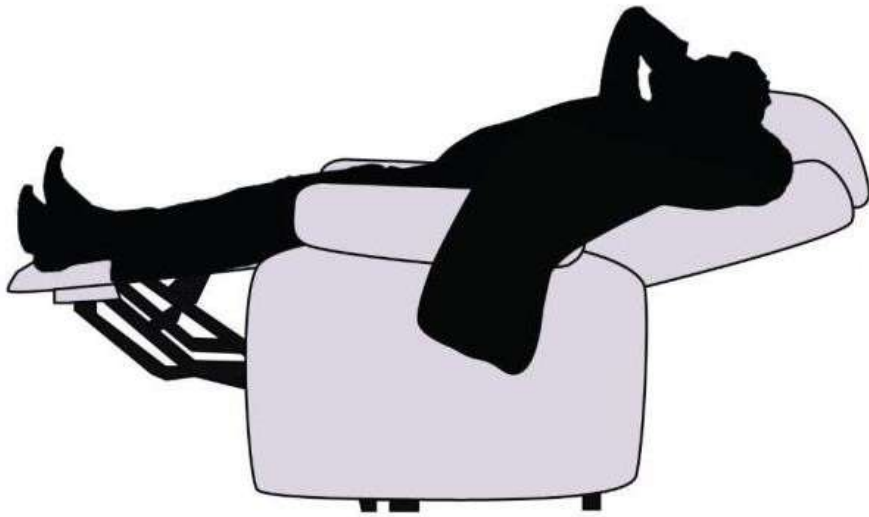

Recliners are the proven way to get rid of stress , backpain and neck pain as per study. Also recliners ease tension from your spine by elevating you to a zero gravity position. With your feet raised to the same level as your heart, the strain on your vertebrae will be decrease to relieve the discomfort of back pain.

**TALKING
POINTS :**



Pocket Spring

Pocket spring embedded at foam in seat for superior cushioning and bounce back action. Due to spring action the seat contracts when weight is exerted on seating surface and regains shape immediately when the weight is remove thus enhancing longevity.

Note : There years warranty is offered in manufacturing defect like structural deformation of frame and malfunction of reclining mechanism

CONTACT DETAILS :

UNIVERSAL MARKETING

**"Universal" House , Near Municipal Shopping Center ,
In Harinagar / Upkar Society, Odhavpura ,
off. Gotri Road , Vadodara 390 007.**

**Ph. no.- 0265-2395295/0265 3569900/
0265 2311020/9428402401/9428402410**

Email:info@universal-marketing.com

VISIT OUR SITE:www.universal-marketing.com